

## PARTS

(1) Hardware

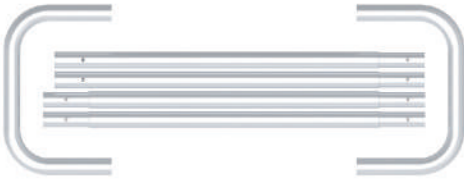

(2) Graphic printing fabric banner



### STEP 01

To connect the poles according to the labellings

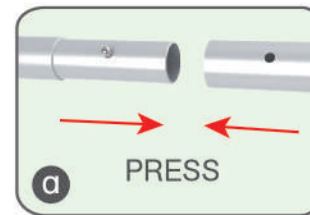
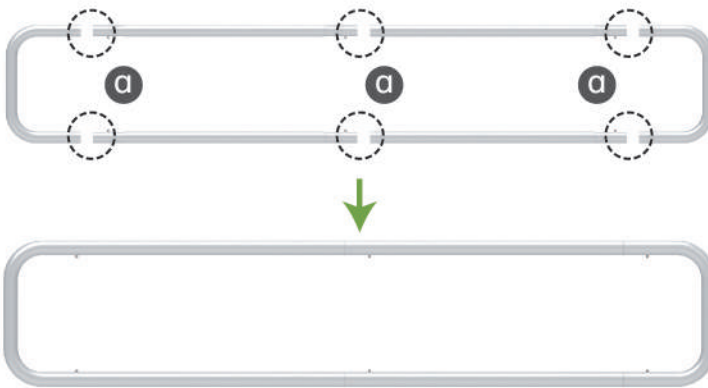

### STEP 02

To wrap up the fabric banner from side to side and zip up



Same steps for below style of headers

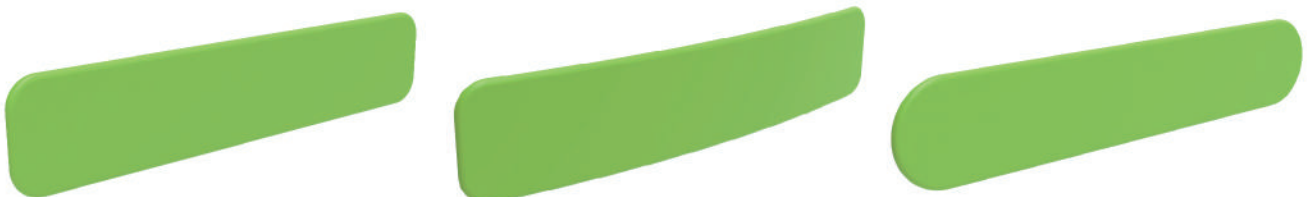

## PARTS

(1) Hardware

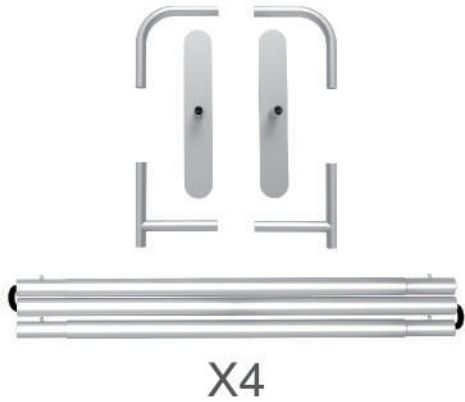

(2) Graphic printing fabric banner

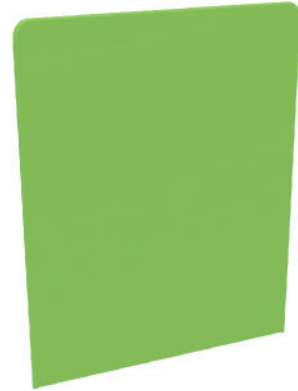

### STEP 01

To connect the poles according to the labellings

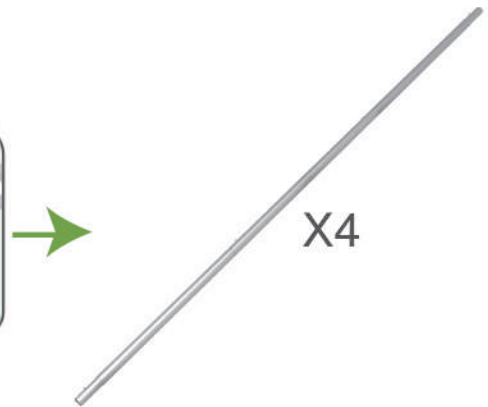
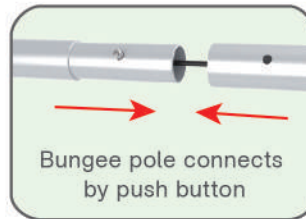
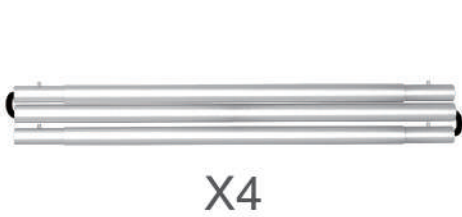

### STEP 02

To connect the long poles by corner pieces according to labellings

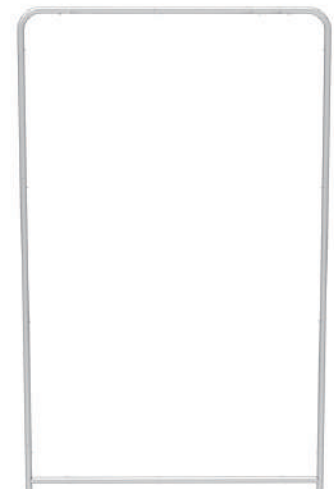
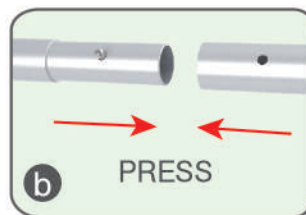
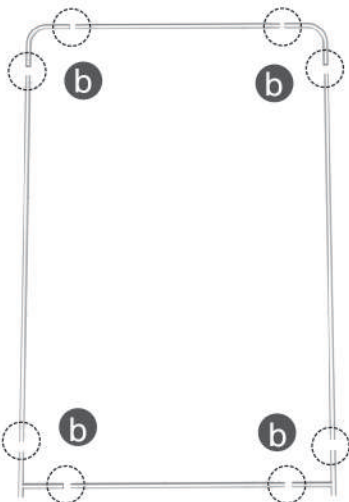

## PARTS

### STEP 03

To slide the fabric banner on the frame from top and zip up at bottom



Same Steps for another Display Wall

### Booth Set Assembly

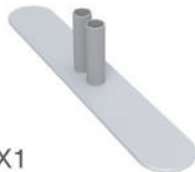
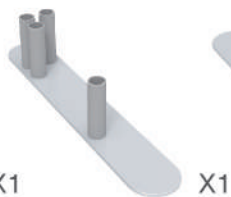
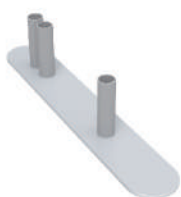
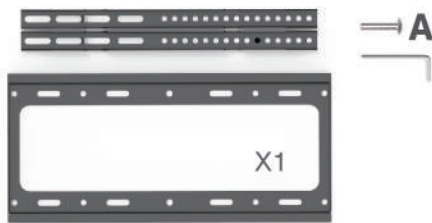

## PARTS

### STEP 01

To lie down the backwall and header and use C clip to connect perfectly

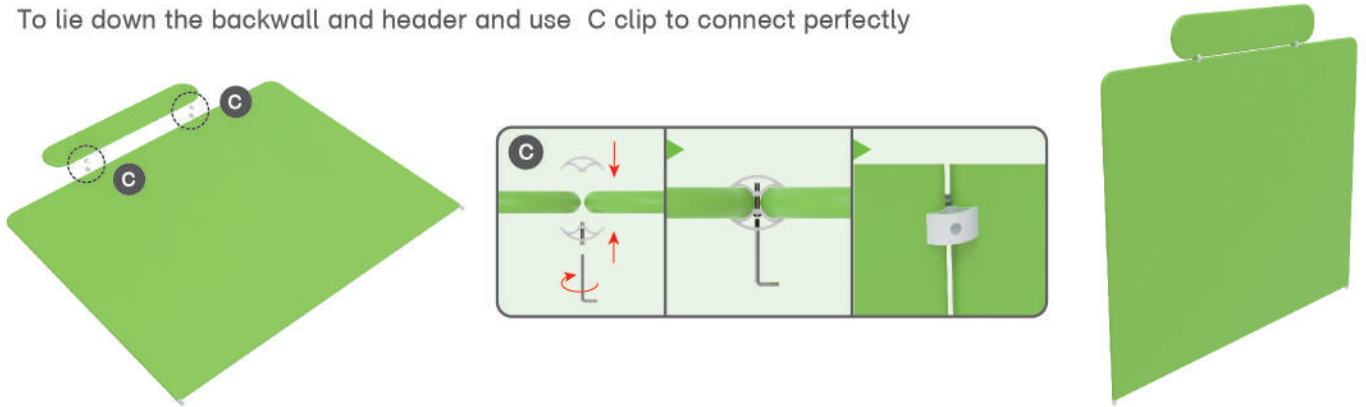

### STEP 02

To assemble the stand feet in position

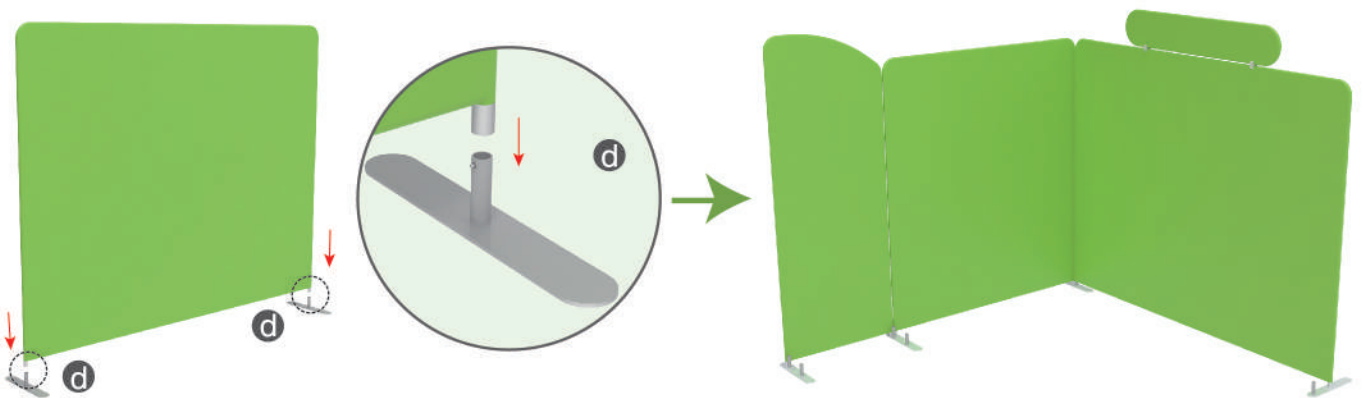

### STEP 03

To install the shelf at right side in position

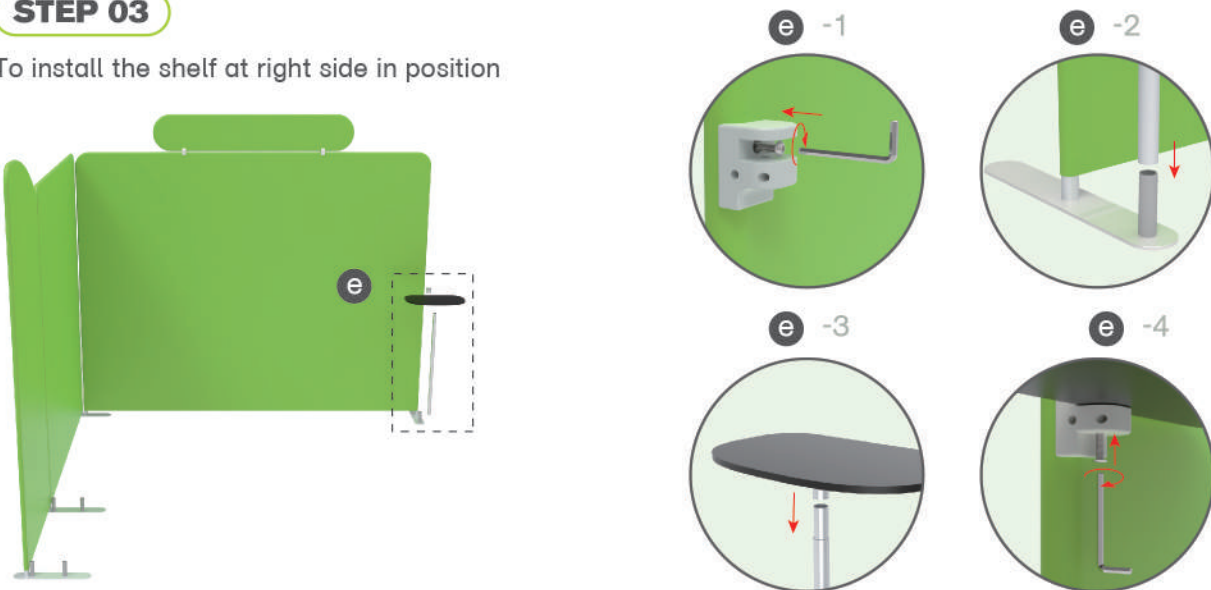

## PARTS

### STEP 04

To install the shelves at left side in position

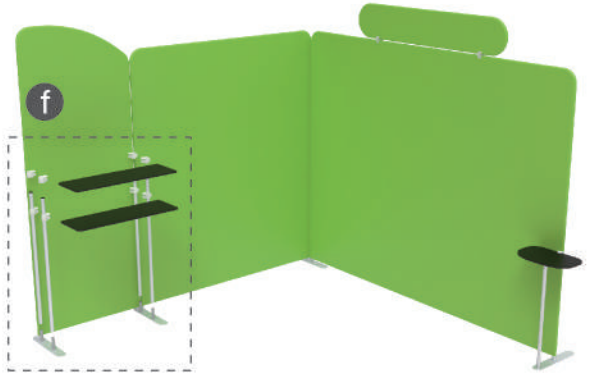

### STEP 05

To use C clip to connect display walls perfectly  
\*\* C clip with both sides same size is for flat connection  
\*\* C clip with 1 big 1 small is for corner connection

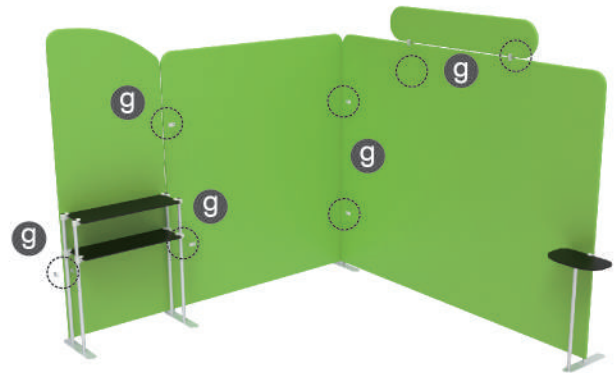
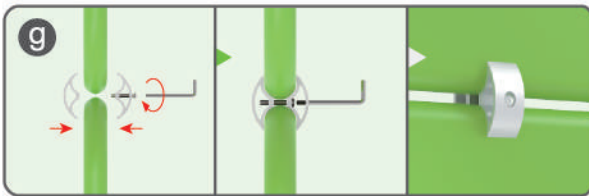

### STEP 06

To install the TV mount in position

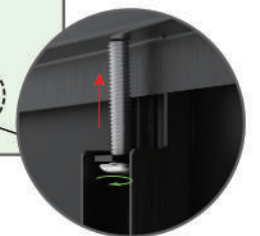
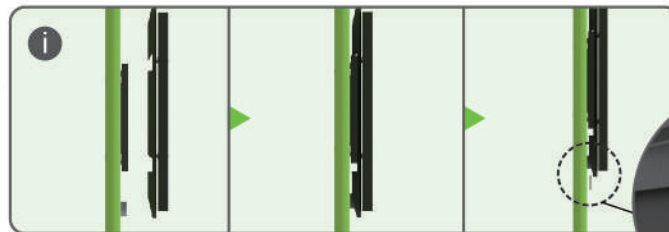
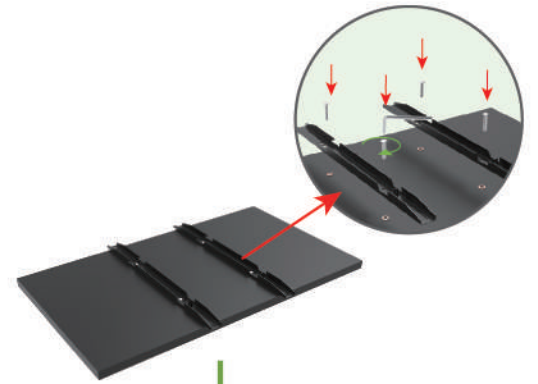
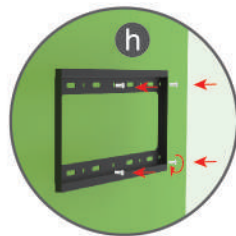



## PARTS

### STEP 07

Install LED light

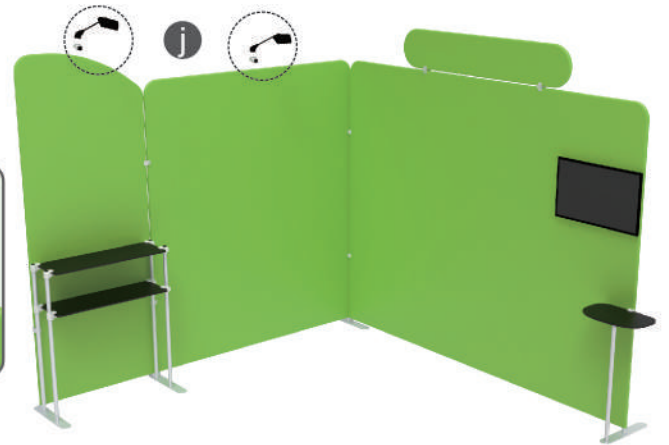
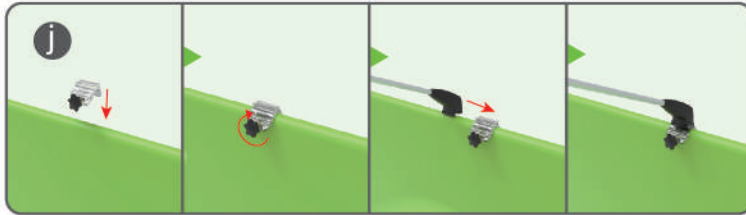

SAME STEPS FOR 10X10ft Booth-U



10X10FT-BOOTH-T



10X10FT-BOOTH-U